

Devices

Battery: Generates \vec{E} -field using chemical energy.

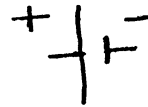

$\varepsilon = \text{emf}$ is actually potential difference between + and - plates.

Capacitor: "Bucket for \vec{E} -field Capacitance $C = \frac{Q}{V}$

Parallel Plates of Area A separated by d , Each plate has charge density $\sigma = \frac{Q}{A}$.

\vec{E} -field is $\vec{E} = \frac{\sigma}{\varepsilon_0} \hat{x}$ [$0 < x < d$]
 $\vec{E} = 0$ at all other x .

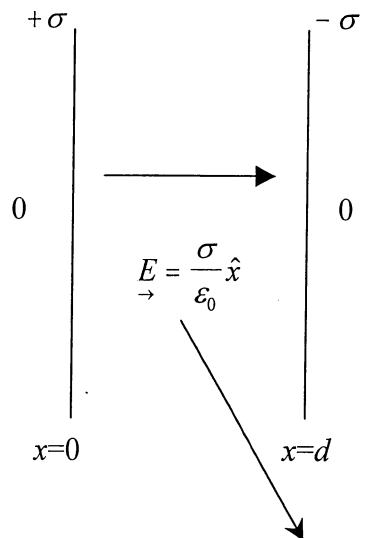

air or vacuum between plates

$$\Delta V = - \int_{\vec{r}_1}^{\vec{r}_2} \vec{E} \cdot d\vec{S} = - \frac{\sigma}{\varepsilon_0} d \text{ so } V = \left| \frac{\sigma}{\varepsilon_0} d \right|$$

$$C = \frac{Q}{V} = \frac{\varepsilon_0 A}{d}$$

$$V = \frac{\sigma}{\varepsilon_0} (d - l)$$

$$C = \frac{\varepsilon_0 A}{d - l} \rightarrow (1)$$

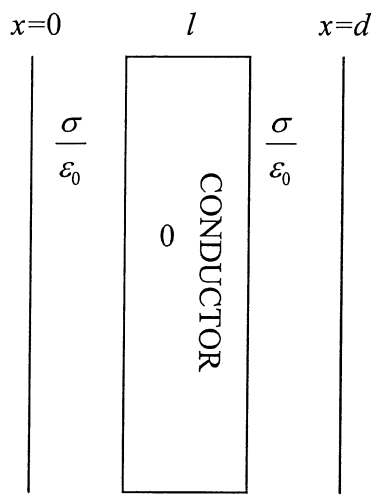

Put conductor of thickness l in

middle. Now

$\vec{E} = 0$ inside conductor

We have

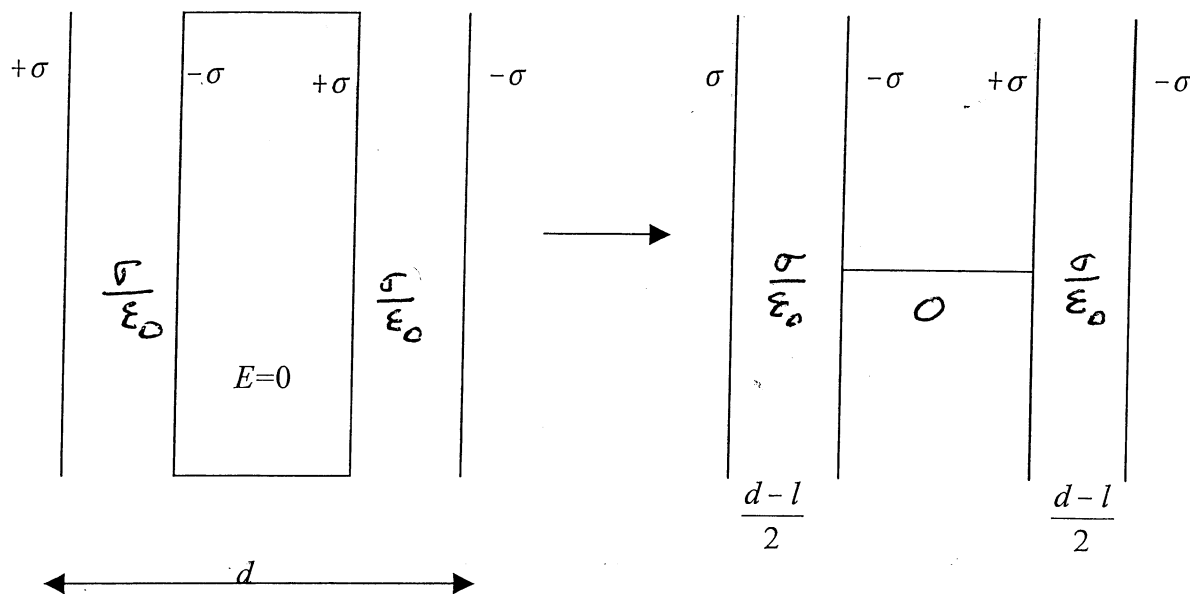

That is, as if two capacitors were in series, Each having $C_1 = C_2 = \frac{2\epsilon_0 A}{d-l}$ (2)

And comparing Eqs. (2) & (1) you see $\frac{1}{C} = \frac{1}{C_1} + \frac{1}{C_2}$

So when capacitors are connected in series, total equivalent capacitance is given by

$$\frac{1}{C_s} = \sum \frac{1}{C_i} \quad \leftarrow \text{SERIES CONNECTION}$$

Dielectric between plates. Dielectric consists of Dipoles. Dielectric is an insulator.

Every dipole feels a

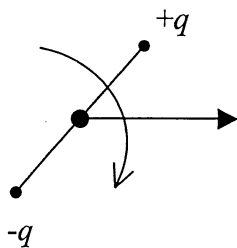

$$\vec{\tau} = \vec{p} \times \vec{E}$$

torque which makes it parallel to the \vec{E} field between the plates hence the system looks like what is shown on next page:

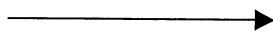
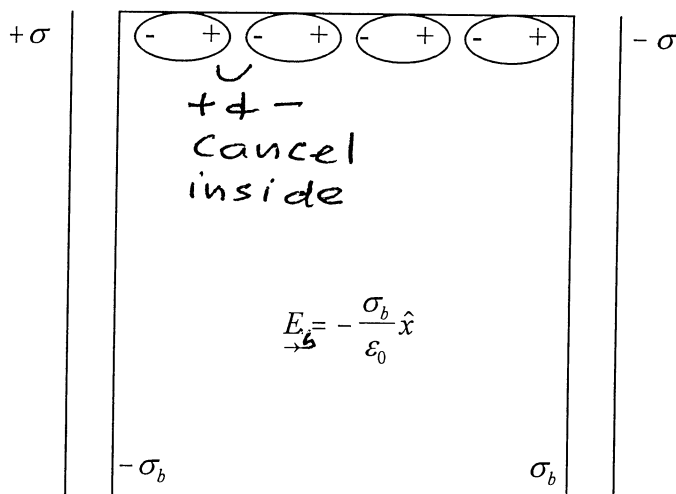

$$\vec{E} = +\frac{\sigma}{\epsilon_0} \hat{x}$$

Dipole in \vec{E} -field experiences torque, which causes each Dipole to line up along \vec{E} .

On surfaces of dielectric charge sheets $+\sigma_b$ and $-\sigma_b$ appear.

\vec{E} -field inside dielectric is the sum of field due to charge on plates $[\frac{\sigma}{\epsilon_0} \hat{x}]$ and that due to charge on surfaces $[-\frac{\sigma_b}{\epsilon_0} \hat{x}]$

Hence,

$$\vec{E}_k = \frac{\sigma - \sigma_b}{\epsilon_0} \hat{x}$$

$$\frac{E_k}{E} = \frac{\sigma - \sigma_b}{\sigma} = \frac{1}{k}$$

k = Dielectric Const. [N.B. k is always > 1].

$$\text{Now } V_k = E_k d = \frac{Ed}{k} = \frac{\sigma d}{\epsilon_0 k}$$

$$\text{So } C_k = \frac{Q}{V_k} = \frac{\sigma A \epsilon_0 k}{\sigma d} = \frac{k \epsilon_0 A}{d}$$

Capacitance is increased by factor k .

Note: in both cases conductor of thickness l between plates or Dielectric of thickness d , potential difference is reduced but physics is totally different!

Next, put the two devices in a circuit:

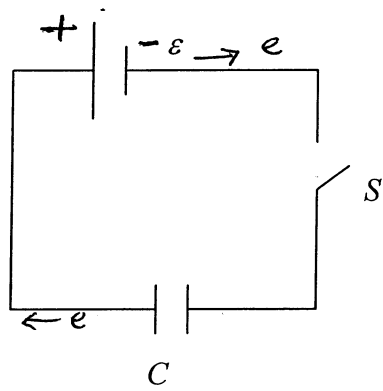

Note: the lines connecting the devices are perfect conductors and so under stationary conditions they must become equipotentials. That is if we close the switch S and wait for a while the Potential difference across C will become ϵ .

$$V = \epsilon$$

$$Q = \epsilon C$$

So the capacitor plates now have $+Q$ (left) and $-Q$ (right). How did this happen? Clearly, the +ive plate of the battery pulled electrons from the left sheet of capacitor while the -ive plate pushed electrons on the right sheet. Effectively, you start with $q=0$ on either sheet, transfer charge from one sheet to the other, so one becomes $-q$ & the other q [However, no flow of charge between capacitor plates]

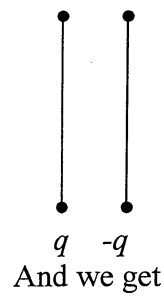

$$V = q/c$$

Now take Δq from rt. To Left. Work done will be

$$DW = \Delta q \frac{q}{C} \text{ area of rectangle. (next page picture)}$$

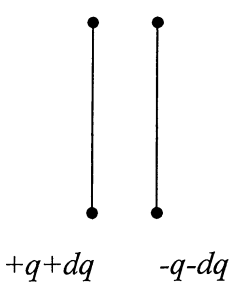

CONSERVATIVE FORCE:
WORK DONE IS INDEPENDENT
OF THE PATH.

To build up charge from 0 to Q you need area of Δ . This work is now $U_E = \frac{1}{2} \cdot Q(Q/C) = \frac{Q^2}{2C}$

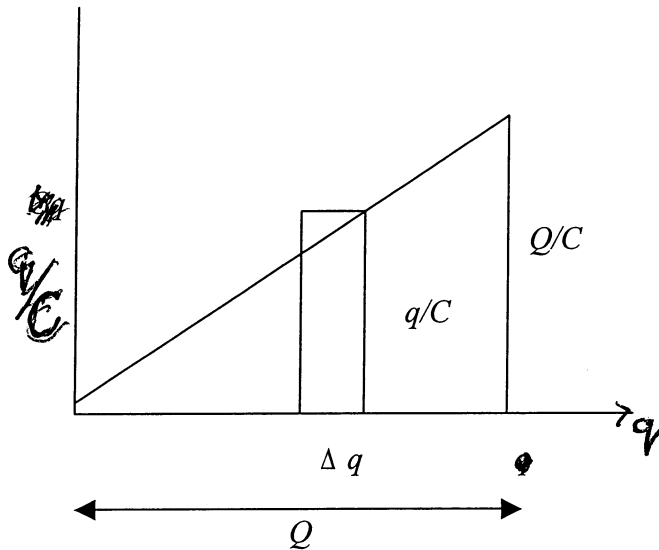

Where does this work go? Notice, space between plates is not empty, there is an \vec{E} -field in it.
This energy is stored as potential energy in that \vec{E} -field.

Apply it to ||-plate [air bet plates] $Q = \sigma A, C = \frac{\epsilon_0 A}{d}$

$$U_E = \frac{\sigma^2 A^2 d}{2\epsilon_0 A}$$

$$= \frac{1}{2} \epsilon_0 E^2 A d$$

$$E = \frac{\sigma}{\epsilon_0}$$

Energy density = $\frac{U_E}{vol} = \frac{U_E}{Ad} = \frac{1}{2} \epsilon_0 E^2$ this is like a "Pressure" $\eta_E = \frac{1}{2} \epsilon_0 E^2$

||-Plate [Dielectric]

$$U_E = \frac{Q^2}{2C_k} = \frac{\sigma^2 A^2 d}{2k\epsilon_0 A}$$

$$= \frac{1}{2} k\epsilon_0 E_k^2 A d$$

$$\eta_E(k) = \frac{1}{2} k\epsilon_0 E_k^2$$

Next, consider the Expt: two identical capacitors.

First, put charges $\pm Q$ on one $U_E = \frac{Q^2}{2C}$

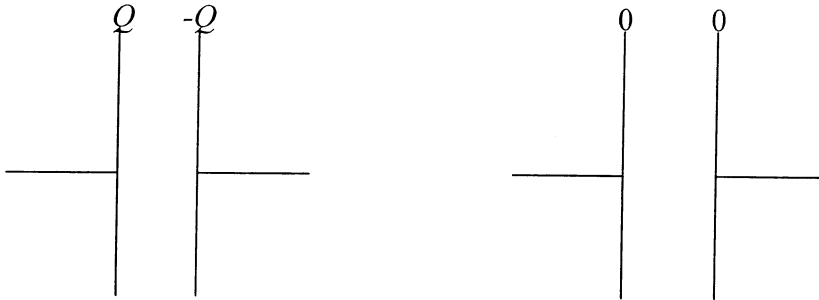

Next, connect left-to-left, right to right to make Equipotentials, now charge will be $\pm \frac{Q}{2}$ on each.

Total Energy $U_E = \frac{2 \cdot 1}{2} \left(\frac{Q}{2}\right)^2 \cdot \frac{1}{C} = \frac{Q^2}{4C}$

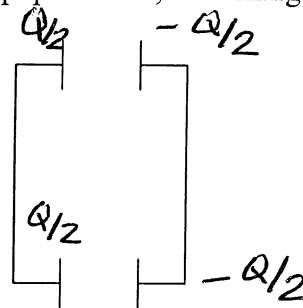

IMP → What happened to half of the energy? In the second half of the experiment charge was transported from one set of plates to the other. This experiment tells us that it costs energy to transport charge through a conductor. This leads us to our third device.

-RESISTOR

First we define current

$$I = \lim_{\Delta t \rightarrow 0} \frac{\Delta Q}{\Delta t}$$

as the amount of charge flowing per second.

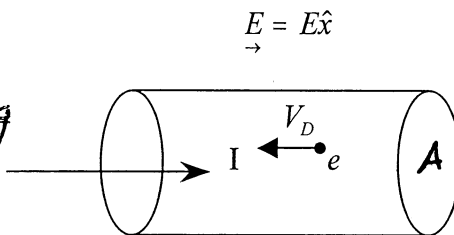

To calculate,

quantity of charge flowing per second, ~~and~~ cross-sectional area is A and since only electrons are mobile one can write $I = n_e (-e) A (-V_D)$

where $n_e = \#$ of mobile electrons/ m^3

$-e = 1.6 \times 10^{-19} C$
 $V_D = \text{drift speed}$

note \bar{v} at

Notice: Direction of I is opposite to that of electron drift.

Recall: $V_D \cong 10^{-4} m/s$. While $V_{rms} \cong 10^5 m/s$ at 300K. This is because ions are stationary and act as scattering centers. Electron has a very tortuous path so although the speed between collisions is high the entire electron "cloud" drifts rather slowly.

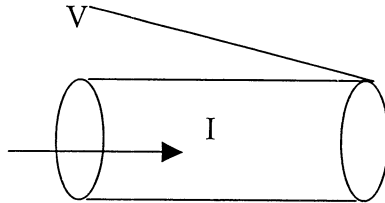

Since transport costs energy, potential must drop. Hence, definition of resistance

$$R = \frac{V}{I}$$

For a particular piece of conductor $R = \frac{\rho l}{A}$

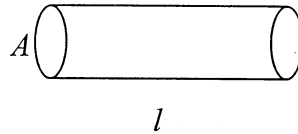

l =length, A = cross-section

ρ = resistivity (material property)

[cf. conduction of heat $\frac{DQ}{\Delta t} = -kA \frac{\Delta T}{\Delta x}$]

$$I = \frac{V}{R} = \frac{\Delta Q}{\Delta t} = \frac{VA}{\rho l} = \sigma A \frac{V}{l}$$

σ = electrical conductivity

It is instructive to write

$$I = \vec{J} \bullet \vec{A}$$

\vec{J} = current density vector

and we know that

$$E = \frac{V}{l}$$

$$\text{so } \vec{J} = \sigma \vec{E}$$

That is, if you apply an \vec{E} -field to a conductor it responds by setting up a current density proportional to E , the proportionality factor being the conductivity (electrical).

KIRCHHOFF'S RULES: PHYSICAL BASIS

Loop Rule: Change of potential between two points is independent of the path because potential is derived from potential energy and the latter is defined for a CONSERVATIVE force so net change of potential on a closed loop must be zero.

$$\sum_{LOOP} \Delta V_i = 0$$

Potential at
any point
is
UNIQUE!

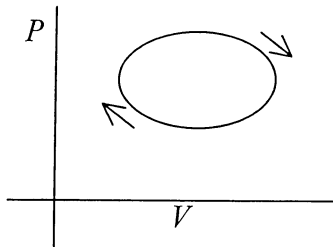

[Recall that in a Thermodynamic cyclic process $dU = 0$, Thermodynamic potential (Internal energy)]

Junction Rule: Flow of charge is continuous, i.e., apart from what is involved in setting up the original field to drive a current, there can be no continuous accumulation (depletion) of charge at junction consequently,

Current is flux of charge, charge is conserved hence charge flow per sec. out of junction must equal charge flow into junction per sec.

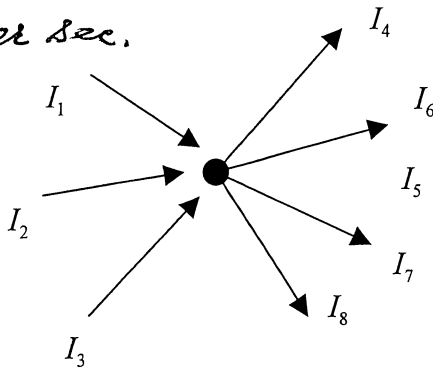

$$\sum I_{out} = \sum I_{in}$$

9/12

Next, put all 3-devices together, in a circuit:

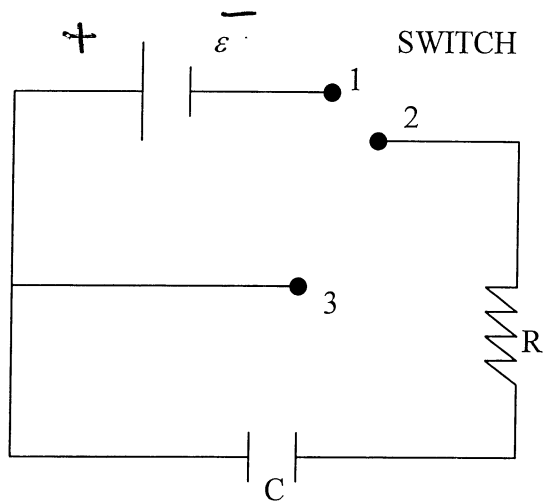

At $t=0$, connect 1 to 2: charge will flow from battery to capacitor plates.

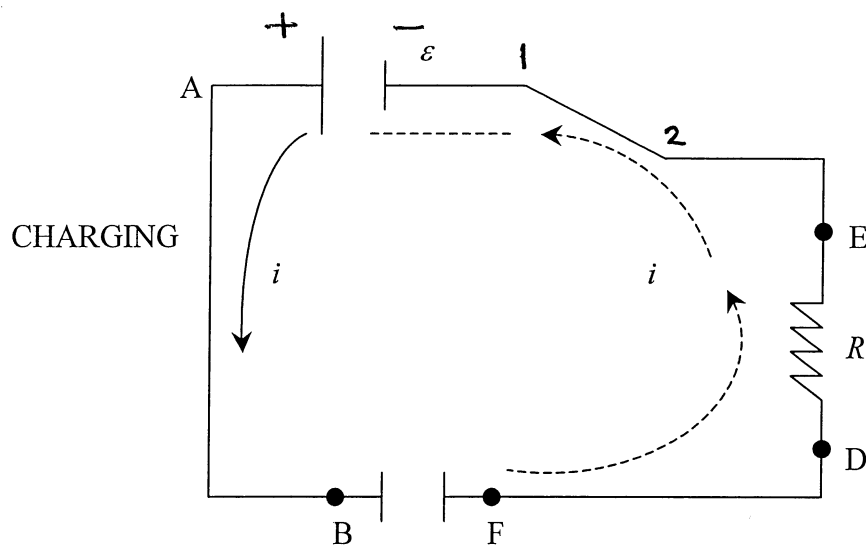

NOTICE NO CURRENT IN CAPACITOR.

At $t=0$, no charge on C , $V_C = 0$, Potential at various points looks like

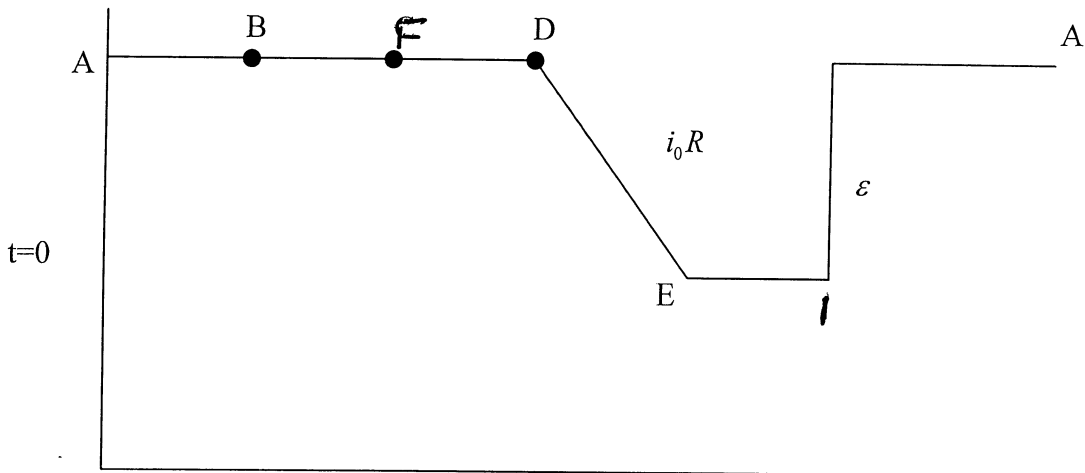

So $i_0 = \frac{\epsilon}{R}$

That is, R limits the maximum current that can flow so it will take time to build up charge on C .

a little later C has $q^+ | q^-$, $V_C = \frac{q}{C}$, and the Potential becomes

a little later

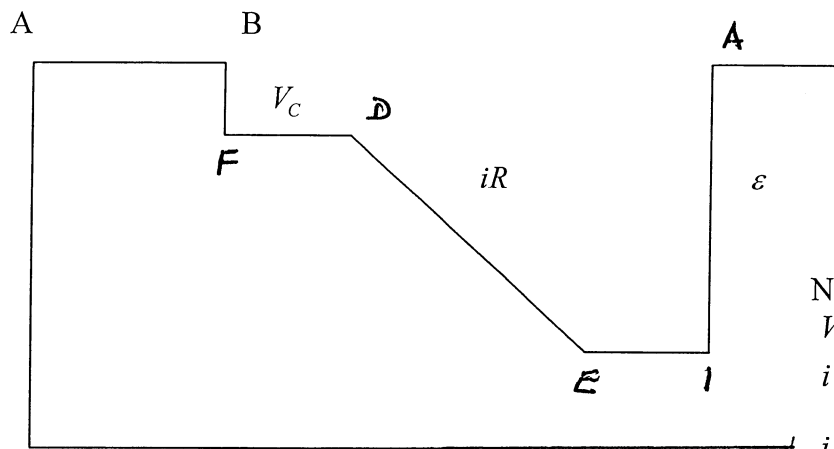

Now
 $V_C + iR = \epsilon$
 $i < i_0$
 $i = \frac{\epsilon - V_C}{R}$

Eventually $q \rightarrow C\varepsilon$

11/12

Long
time
later

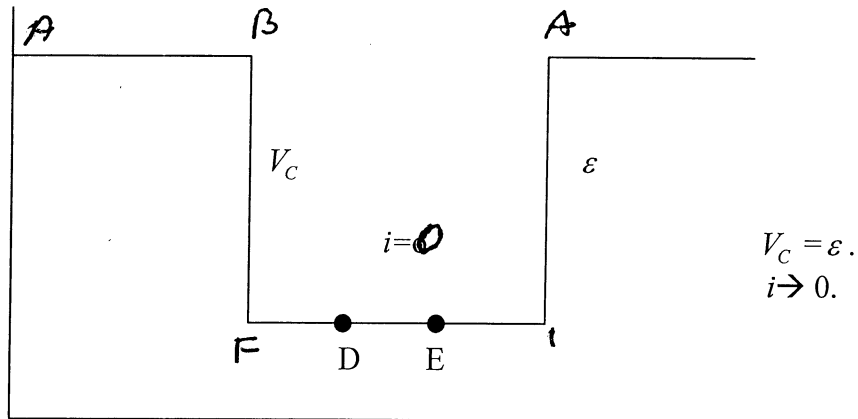

Mathematically it can be proved that:

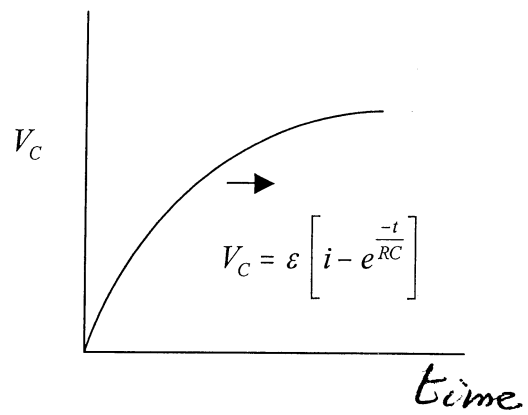
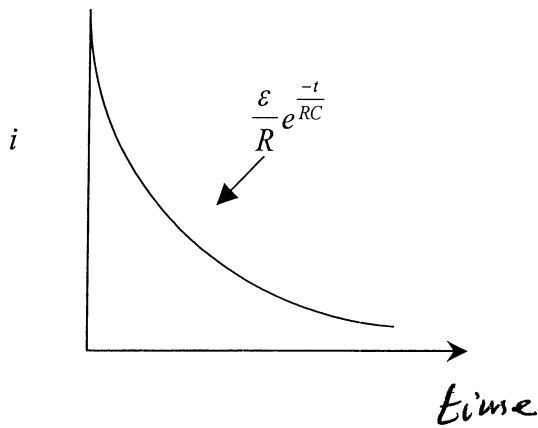

So now $V_C = \varepsilon, i=0$

Switch from $2 \rightarrow 1$ to $2 \rightarrow 3$. circuit is

Start clock again

DISCHARGING

No Battery in Circuit
Current is due to capacitor's
stored charge (E-field) 12/12

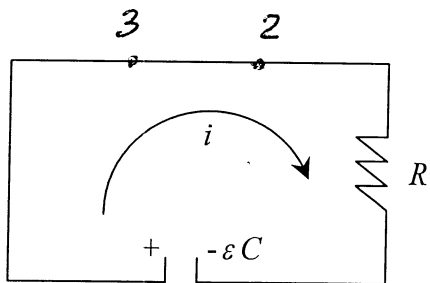

current flows in opposite direction

NO CURRENT IN CAPACITOR

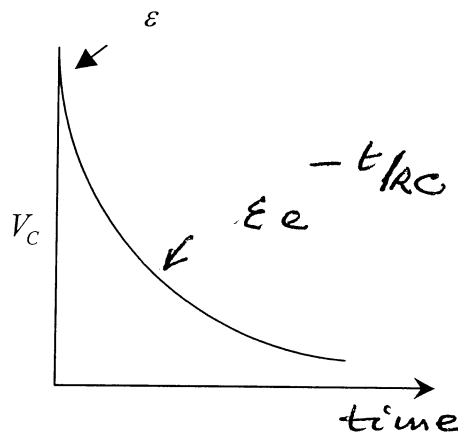
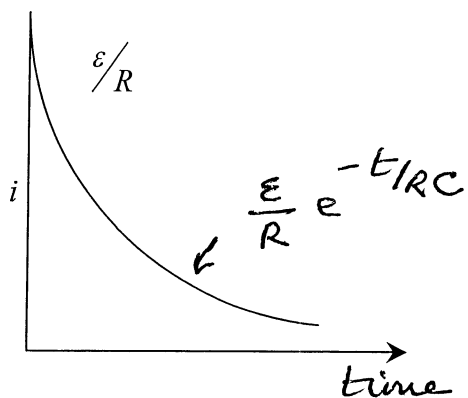

CHARACTERISTIC TIME $\tau = RC!!!$

$$R = \frac{V}{I} \Rightarrow \frac{VT}{Q}$$

$$C = \frac{Q}{V}$$

$$\text{SO } RC \Rightarrow \frac{Q}{V} \cdot \frac{VT}{Q} \Rightarrow T$$

RC has dimension of time!